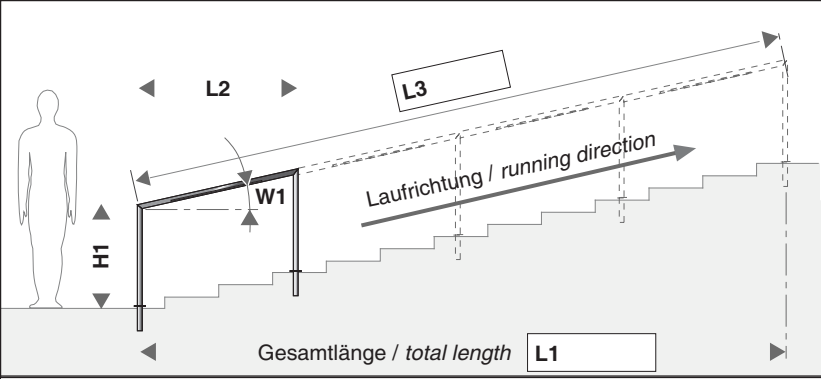
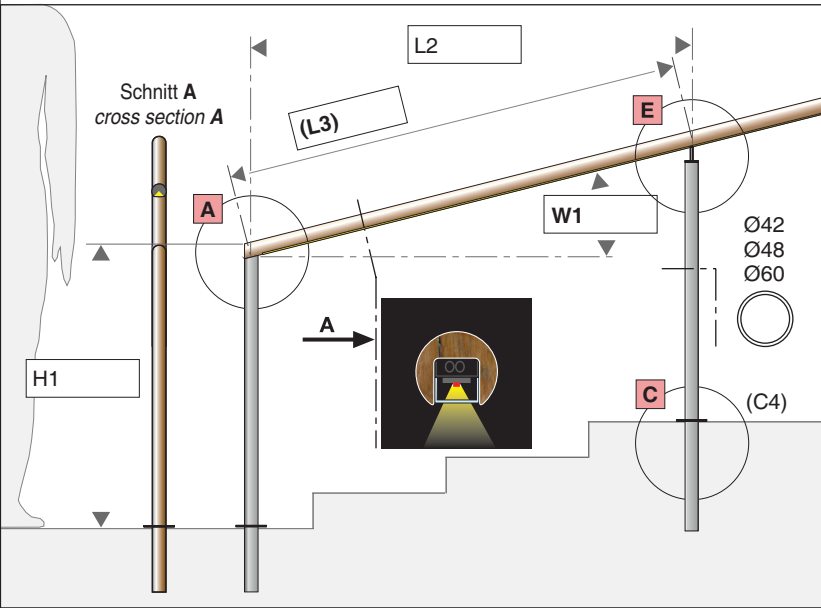
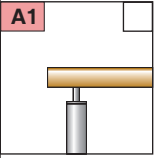
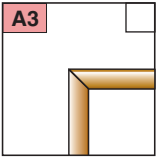
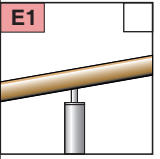
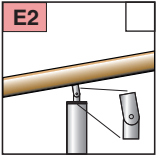
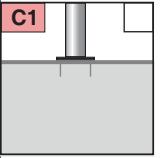
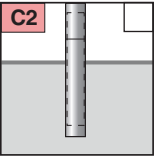
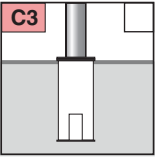
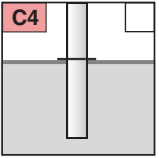
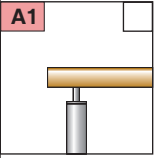
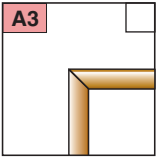
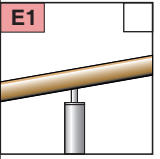
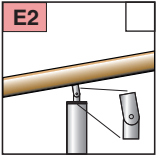
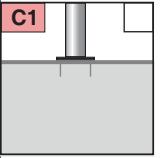
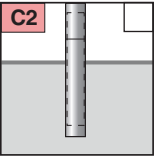
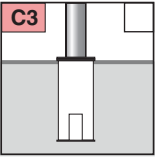
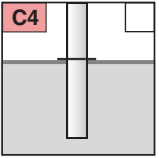
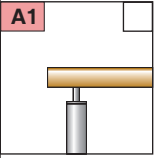
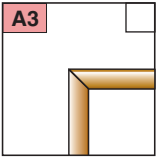
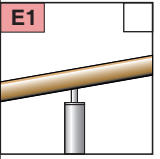
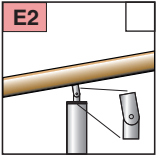
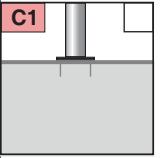
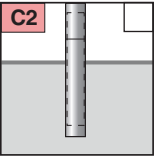
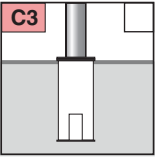
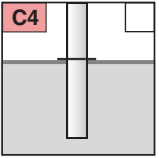
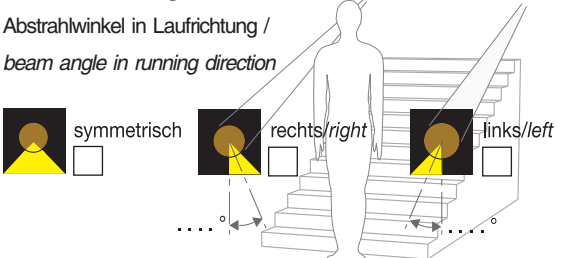

Datenblatt / data sheet

U42 / U50 / U60 Holz (auf Boden) / wood (on ground)

Alle Modelle sind international gesetzlich geschützt.
All models are protected by international law.

Projekt / project:	Bestellnr. / item no.:	Datum / date:																				
Handlauf Übersicht / handrail overview																						
																						
Notizen / notices :																						
Handlauf Details / handrail details																						
																						
<table border="0" style="width: 100%;"> <tr> <td style="width: 15%;">A1</td> <td style="width: 15%;">A3</td> <td rowspan="2">Stützen in Holz auf Anfrage / pillars in wood on request</td> </tr> <tr> <td></td> <td></td> </tr> <tr> <td>E1</td> <td>E2</td> <td></td> </tr> <tr> <td></td> <td></td> <td></td> </tr> <tr> <td>C1</td> <td>C2</td> <td>C3</td> </tr> <tr> <td></td> <td></td> <td></td> </tr> <tr> <td>C4</td> <td colspan="2"></td> </tr> </table>			A1	A3	Stützen in Holz auf Anfrage / pillars in wood on request			E1	E2					C1	C2	C3				C4		
A1	A3	Stützen in Holz auf Anfrage / pillars in wood on request																				
																						
E1	E2																					
																						
C1	C2	C3																				
																						
C4																						
Handlaufleuchte / handrail luminaire U-Profil Holzart / U-profile wood type: U42 - Ø 42 mm <input type="checkbox"/> U50 - Ø 50 mm <input type="checkbox"/> U60 - Ø 60 mm <input type="checkbox"/>																						
Holzoberfläche / wood surface: farblos lackiert / painted colourless <input type="checkbox"/> geölt / oiled <input type="checkbox"/> geölt mit UV-Schutz / oiled with UV-protection <input type="checkbox"/> Holzlasur mit UV-Schutz / wood stain with UV-protection <input type="checkbox"/>																						
Lichtauslass / light outlet : Abstrahlwinkel in Laufrichtung / beam angle in running direction																						
																						
Schutzabdeckung / protection cover : PC Glas: transparent <input type="checkbox"/> leicht mattiert/slightly frosted <input type="checkbox"/>																						
Technik / technology : Schutzart / protection class : IP54 Weitere auf Anfrage / more on request Schutzklasse / electrical safety class : 1 <input type="checkbox"/> 2 <input type="checkbox"/> 3 <input type="checkbox"/>																						
Lichttechnik / light technique: LED Nr./No. : Lichtfarbe / colour temperature (CCT): LED Schutzart / LED protection class : IP65 <input type="checkbox"/> IP68 <input type="checkbox"/> Weitere / more :																						
Stützen Material / pillar material: V2A (1.4301 / 304L) <input type="checkbox"/> V4A (1.4401 / 316L) <input type="checkbox"/> Holz auf Anfrage / wood on request Oberfläche / surface: glasperlengestrahlt / glass-bead blasted <input type="checkbox"/> geschliffen Korn240 / polished grain240 <input type="checkbox"/> pulverbeschichtet / powder coated RAL <input type="checkbox"/> DB <input type="checkbox"/>																						
Abmessungen / dimensions : Geländerhöhe H1 / handrail height H1 : Gesamtlänge L1 / total length L1 : Gesamtlänge L3 / total length L3 : Stützenabstand L2 / pillar distance L2 : Steigung Winkel W / gradient angle W : Anzahl Stützen / number of pillars : Anzahl Gehrungen / number of miters : Entfernung Netzteil/ distance power supply :m																						
Nähere Details auf Seite 2 / further details on page 2																						

Datenblatt / data sheet

U42 / U48 / U60 Holz Details / wood

Alle Modelle sind international gesetzlich geschützt.
All models are protected by international law.

Projekt / project:	Bestellnr. / item no.:	Datum / date:
---------------------------	-------------------------------	----------------------

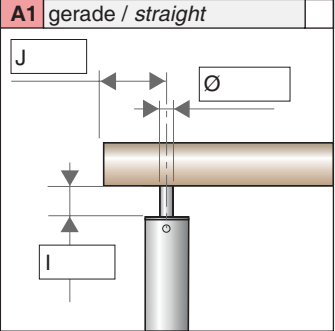
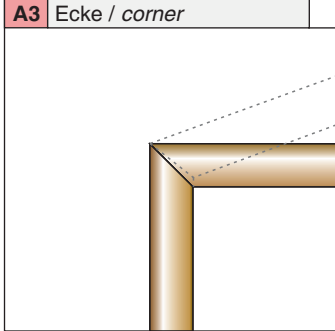
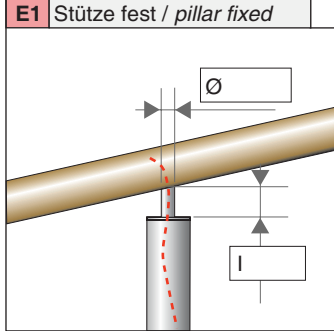
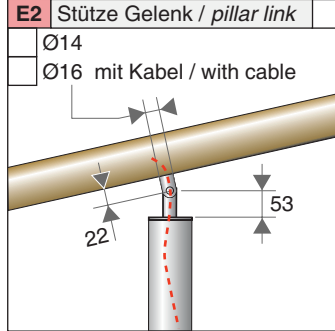
Handlaufenden - Endpfosten / handrail ends		Handlauf - Mittelpfosten / handrail middle pillars	
A1 gerade / straight	A3 Ecke / corner	E1 Stütze fest / pillar fixed	E2 Stütze Gelenk / pillar link
			

Ballustradenverbindung / ballustrade-connection

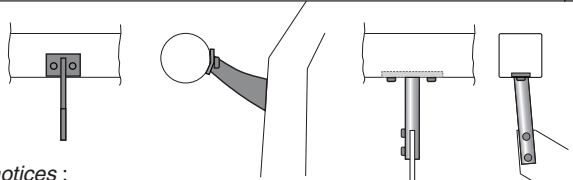
E4 Verbindung kundenspezifisch / customized connectors
Beispiele examples 
Notizen / notices :

Bodenbefestigungen / floor mountings

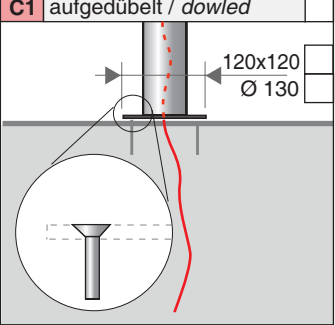
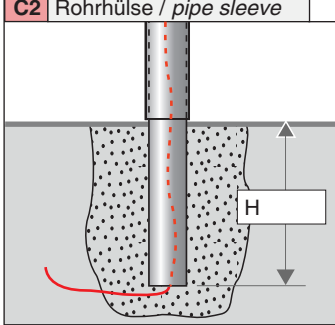
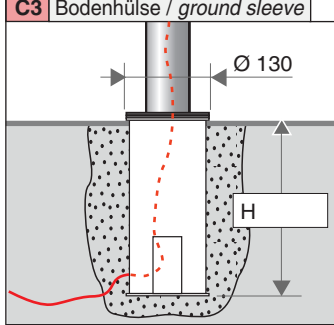
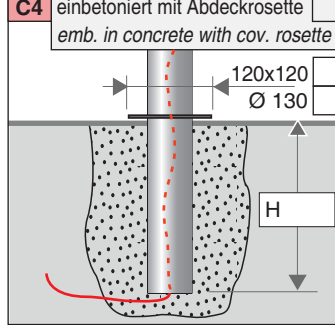
C1 aufgedübelt / dowled	C2 Rohrhülse / pipe sleeve	C3 Bodenhülse / ground sleeve	C4 einbetoniert mit Abdeckrosette emb. in concrete with cov. rosette
			

Schnittstelle / connection E1 Detail

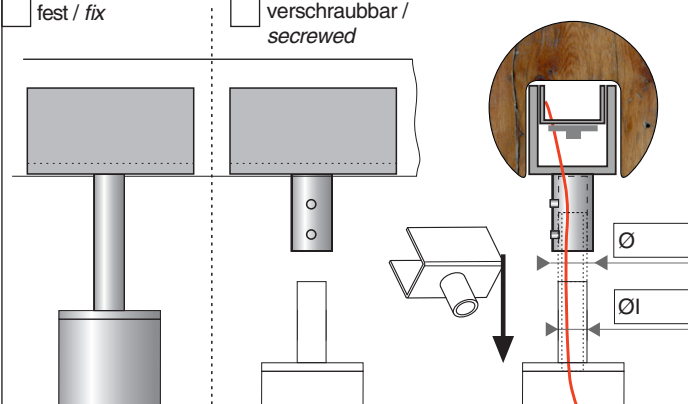



<input type="checkbox"/> fest / fix	<input type="checkbox"/> verschraubbar / screwed
	

Notizen / notices :
.....
.....
.....

Datenblatt / data sheet

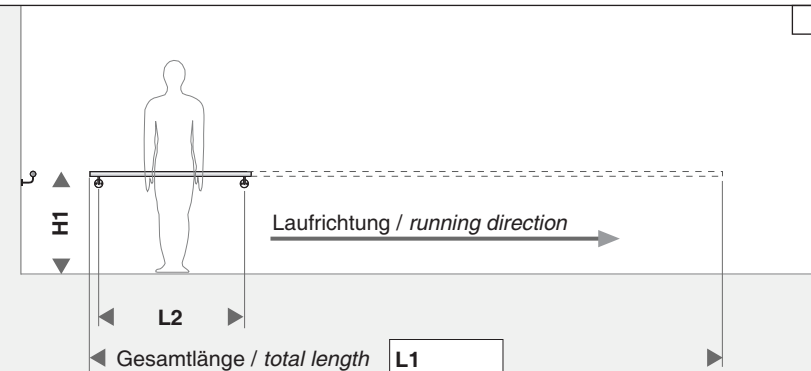
U42 / U50 / U60 Holz (an Wand) / wood (wall-mounted)

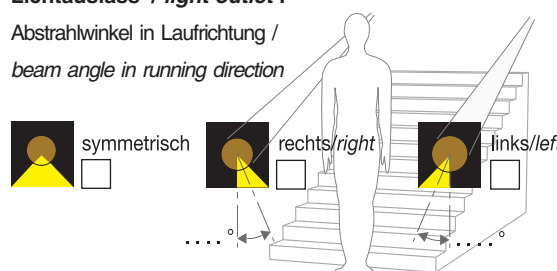
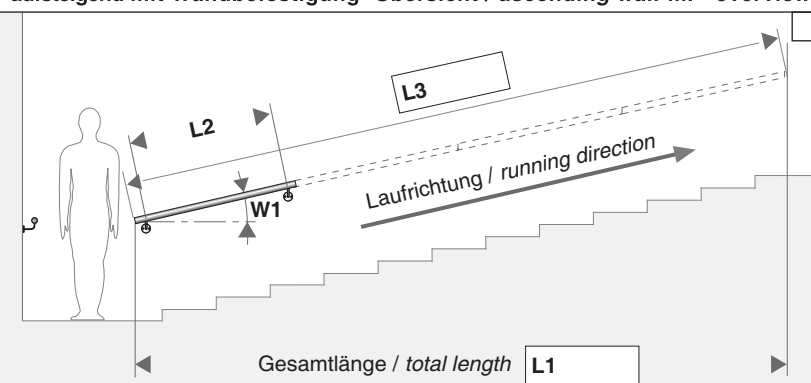
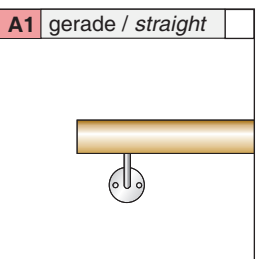
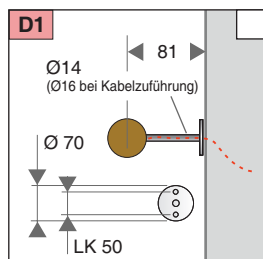
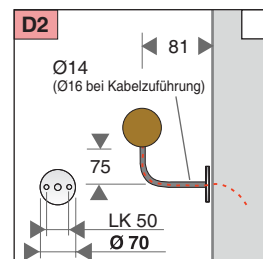
Alle Modelle sind international gesetzlich geschützt.
All models are protected by international law.

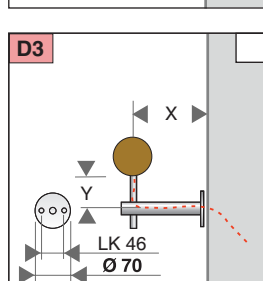
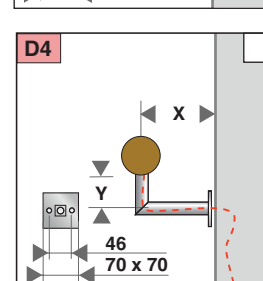
Projekt / project:	Bestellnr. / item no.:	Datum / date:
<p>horizontal mit Wandbefestigung - Übersicht / horizontally wall-mounted - overview</p>  <p>Handlaufleuchte Wand mit Wandbefestigung <i>handrail luminaire wall-mounted</i></p> <p>U-Profil Holzart / U-profile wood type:</p> <p>  U42 - Ø 42 mm <input type="checkbox"/> U50 - Ø 50 mm <input type="checkbox"/> U60 - Ø 60 mm <input type="checkbox"/> </p> <p>Holzoberfläche / wood surface:</p> <p> farblos lackiert / <i>painted colourless</i> <input type="checkbox"/> geölt / <i>oiled</i> <input type="checkbox"/> geölt mit UV-Schutz / <i>oiled with UV-protection</i> <input type="checkbox"/> Holzlasur mit UV-Schutz / <i>wood stain with UV-protection</i> <input type="checkbox"/> </p> <p>Lichtauslass / light outlet:</p> <p>Abstrahlwinkel in Laufrichtung / <i>beam angle in running direction</i></p>  <p> <input type="checkbox"/> symmetrisch <input type="checkbox"/> rechts/right <input type="checkbox"/> links/left </p> <p>Schutzabdeckung / <i>protection cover</i> :</p> <p>PC Glas: transparent <input type="checkbox"/> leicht mattiert/<i>slightly frosted</i> <input type="checkbox"/></p> <p>Technik / technology :</p> <p>Schutzart / <i>protection class</i> : IP54 Weitere auf Anfrage / <i>more on request</i> Schutzklasse / <i>electrical safety class</i> : 1 <input type="checkbox"/> 2 <input type="checkbox"/> 3 <input type="checkbox"/></p> <p>Lichttechnik / light technique:</p> <p>LED Nr./No. : Lichtfarbe / <i>colour temperature (CCT)</i>: LED Schutzart / <i>LED protection class</i> : IP65 <input type="checkbox"/> IP68 <input type="checkbox"/></p>		
<p>Notizen / <i>notices</i> :</p> <p>.....</p> <p>.....</p>		
<p>aufsteigend mit Wandbefestigung- Übersicht / ascending wall-m. - overview</p>  <p>aufsteigend mit Wandbefestigung- Übersicht / ascending wall-m. - overview</p> <p>Abstrahlwinkel in Laufrichtung / <i>beam angle in running direction</i></p> <p>Schutzabdeckung / <i>protection cover</i> :</p> <p>PC Glas: transparent <input type="checkbox"/> leicht mattiert/<i>slightly frosted</i> <input type="checkbox"/></p> <p>Technik / technology :</p> <p>Schutzart / <i>protection class</i> : IP54 Weitere auf Anfrage / <i>more on request</i> Schutzklasse / <i>electrical safety class</i> : 1 <input type="checkbox"/> 2 <input type="checkbox"/> 3 <input type="checkbox"/></p> <p>Lichttechnik / light technique:</p> <p>LED Nr./No. : Lichtfarbe / <i>colour temperature (CCT)</i>: LED Schutzart / <i>LED protection class</i> : IP65 <input type="checkbox"/> IP68 <input type="checkbox"/></p>		
<p>Notizen / <i>notices</i> :</p> <p>.....</p> <p>.....</p>		
<p>A1 gerade / <i>straight</i></p> 	<p>D1</p> 	<p>D2</p> 
<p>A1 gerade / <i>straight</i></p> 	<p>D3</p> 	<p>D4</p> 
<p>Nähere Details auf Seite 2 / <i>further details on page 2</i></p>		
<p>Abmessungen / dimensions :</p> <p>Geländerhöhe H1 / <i>handrail height H1</i> :</p> <p>Gesamtlänge L1 / <i>total length L1</i> :</p> <p>Halterabstand L2 / <i>pillar distance L2</i> :</p> <p>Gesamtlänge L3 / <i>total length L3</i> :</p> <p>Steigung Winkel W / <i>gradient angle W</i> :</p> <p>Anzahl Wandhalter / <i>number of wall-mountings</i> :</p> <p>Anzahl Gehrungen / <i>number of miters</i> :</p> <p>Entfernung Netzteil/ <i>distance power supply</i> : m</p> <p>Details nach Wahl / <i>details on request</i> :</p> <p>Details nach Wahl / details on request :</p>		