

LECCOR®

Pollerleuchten
Standrohrleuchten

Bollard luminaires
Light columns

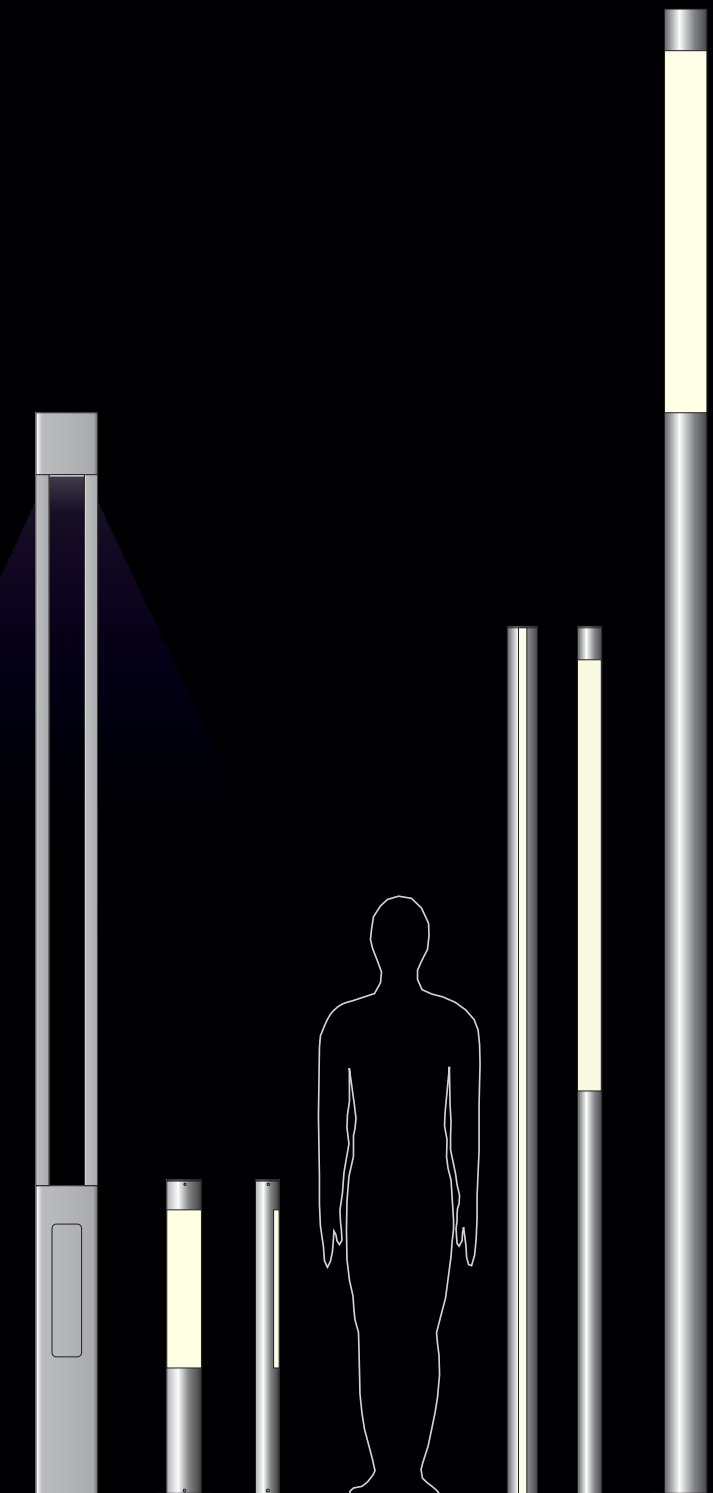

Edelstahl Poller-/ Standrohrleuchten · *Stainless steel bollards / light columns*
Ø 68 / 76 / 114 / 140 mm | 200 x 200 mm

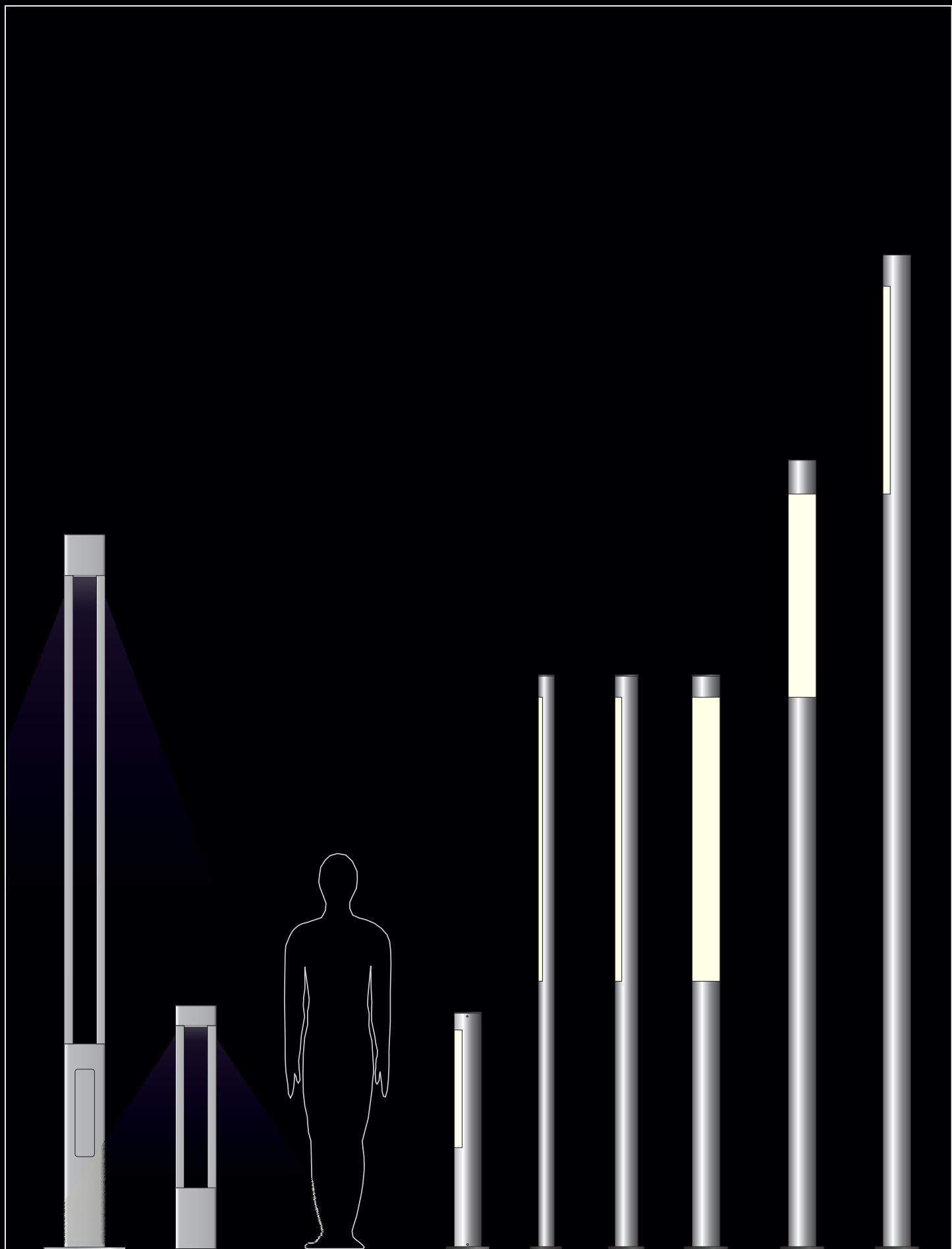

Unsere Edelstahlleuchten bieten eine solide und langfristige Lichtlösung für den öffentlichen wie auch privaten Bereich. Das gradlinige Design bestehend aus runden, wie auch quadratischen Rohrelementen ist wartungsfreundlich und die Lichtleiste kann bei Bedarf auch in Zukunft noch ausgetauscht bzw. umgerüstet werden.

Designrohr:

- Ø 68 mm, Ø 76,1 mm, Ø 114,3 mm, Ø 140 mm, Länge A = 1000 mm / 1700 mm / 2070 mm / 2850 - 5900 mm (weitere Längen und Durchmesser auf Anfrage), Edelstahl V2A (V4A), Oberfläche glasperlengestrahlt, auf Wunsch Pulverbeschichtung möglich
- Lichtauslasswinkel B = 90°, 120°, 2 x 90° oder 360°

Schutzrohr:

- Polycarbonat
- mattiert oder transparent
- schlagfest, staubdicht und strahlwassergeschützt

Leuchtmittel:

- LED: 12/24 Volt, 230 Volt, Direktanschluss (90-277 V) auch ohne Netzteil möglich. Lichtfarbe weiß 2700 K - 5000 K, optional: RGB(W)-Lichtfarben mit zusätzlicher Steuerung PWM oder DALI
- Abstrahlwinkel LED-Linse: 60° oder 120°
- T5 FH Ø 16 mm: 14 W, 21 W, 28 W, 35 W (auf Anfrage)
- T5 FQ Ø 16 mm: 24 W, 49 W, 54 W (auf Anfrage)
- weitere Leuchtmittel auf Anfrage

Technik:

- Schutzart IP54, IP65
- Schutzklasse 1 / 2 / 3

Allgemeine Informationen:

- Prüfzeichen: siehe Homepage
- Alle Modelle sind gesetzlich geschützt
- Technische Änderungen behalten wir uns vor

Our stainless steel luminaires offer a solid and long-term lighting solution for the public as well as the private sector. The straight-lined design consisting of round and square tube elements is maintenance-friendly and the light bar can still be replaced or converted in the future.

Stainless steel tube:

- Ø 68 mm, Ø 76,1 mm, Ø 114,3 mm, Ø 140 mm, length A = 1000 mm / 1700 mm / 2070 mm / 2850 - 5900 mm (other lengths and diameters on request), stainless steel type L304 / L316, glass bead blasted surface, powder coating on request
- angle of light outlet B = 90°, 120° or 2 x 90°

Protection tube:

- polycarbonate
- frosted or transparent
- shock-, dust- and jet-proof

Illuminant:

- LED: 12/24 V or direct connection (90-277V), no mains adapter needed colour temperature (CCT) 2700 K - 5000 K optional: RGB-LED (requires control unit - PWM or DALI)
- angle of radiation LED lenses: 60° or 120°
- T5 FH Ø 16 mm: 14 W, 21 W, 28 W, 35 W
- T5 FQ Ø 16 mm: 24 W, 49W, 54 W
- further illuminants on request

Technology:

- protection class IP54, IP65, electrical safety class 1 / 2 / 3.

General information:

- certificates: see homepage
- all our products are protected by international law
- technical changes reserved

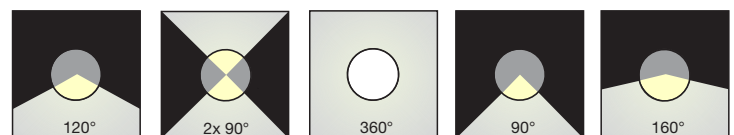

Lichtauslasswinkel B · tube cut-out angle B | optional

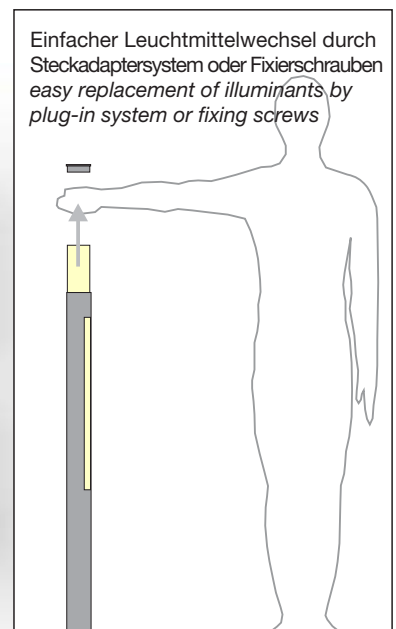



Werkfoto



Werkfoto

Optional
Varianten Lichtausschnitt
variants light outlets

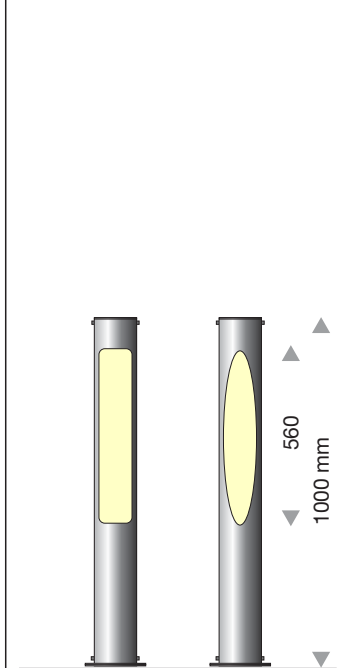

Bestell Nr. / item no.	Ø light source
Ecken rund / round corners	
LED504050410114RD	114 LED 9 Watt
504050410114124RD	114 T5/ 24 Watt
LED504050410140RD	140 LED 9 Watt
504050410140124RD	140 T5/ 24 Watt
Ellipse / ellipse	
LED504050410114EL	114 LED 9 Watt
504050410114124EL	114 T5/ 24 Watt
LED504050410140EL	140 LED 9 Watt
504050410140124EL	140 T5/ 24 Watt

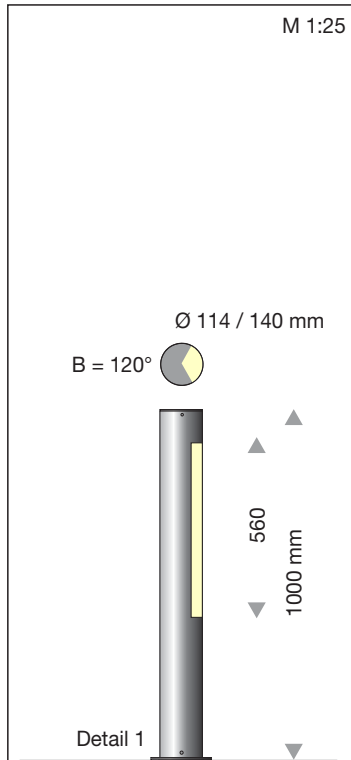

Bestell Nr. / item no.	Ø light source
LED504050410114	114 LED 9 Watt
504050410114124	114 T5/ 24 Watt
LED504050410140	140 LED 9 Watt
504050410140124	140 T5/ 24 Watt

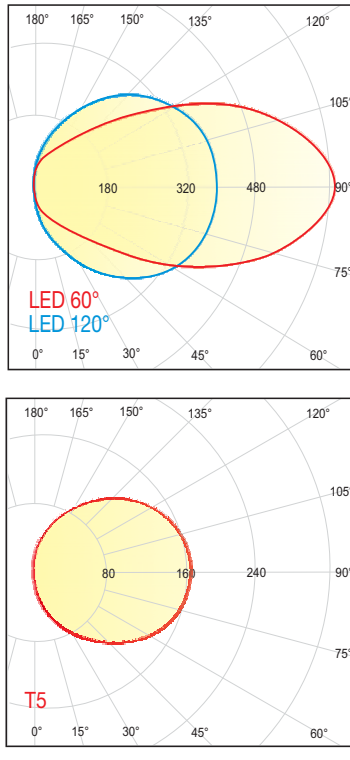

Bestell Nr. / item no.	für / for Ø
500102486	D114
500102487	D140

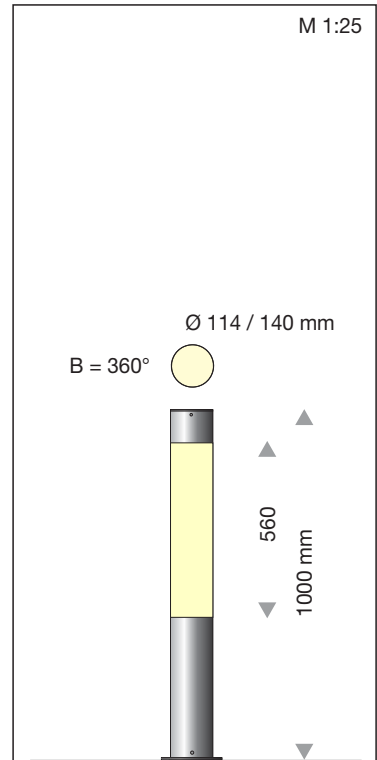

Bestell Nr. / item no.	Ø light source
LED504060410114	114 LED 27 Watt
504060410114124	114 T5/ 24 Watt
LED504060410140	140 LED 27 Watt
504060410140124	140 T5/ 24 Watt

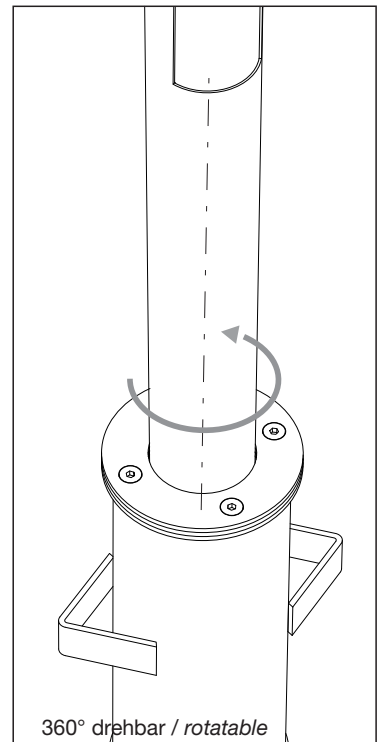
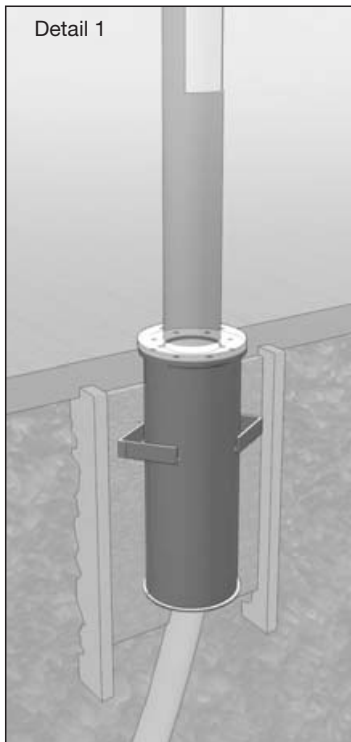

COLLONA

Standrohrleuchten · *Light columns* Ø 114 / Ø 140



Jürgen Weller Fotografie

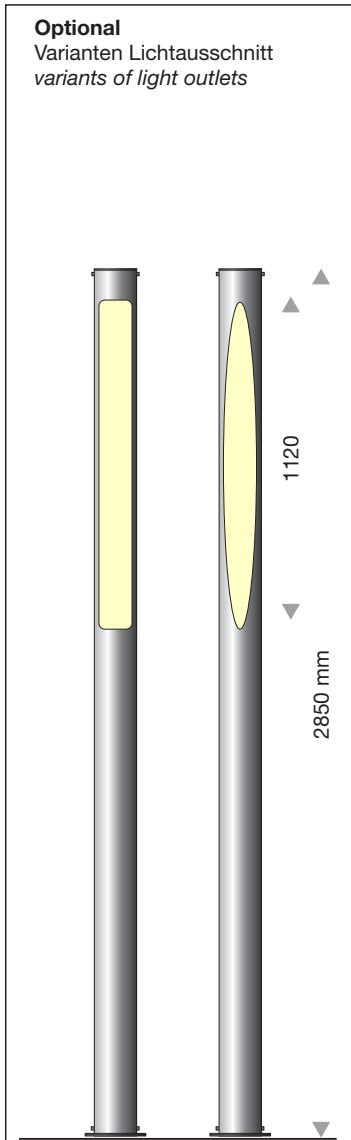

Bestell Nr. / item no.	Ø light source
Ecken rund / round corners	
LED504050510114RD	114 LED 18 Watt
504050510114154RD	114 T5/ 54 Watt
LED504050510140RD	140 LED 18 Watt
504050510140154RD	140 T5/ 54 Watt
Ellipse / ellipse	
LED504050510114EL	114 LED 18 Watt
504050510114154EL	114 T5/ 54 Watt
LED504050510140EL	140 LED 18 Watt
504050510140154EL	140 T5/ 54 Watt

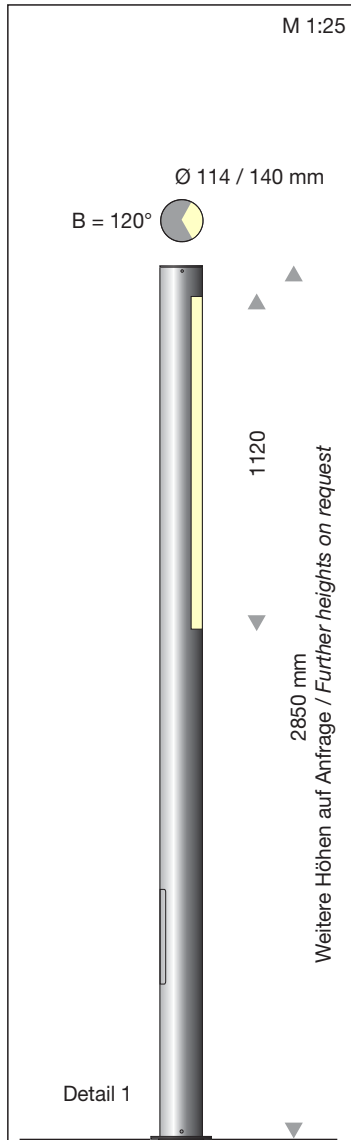

Bestell Nr. / item no.	Ø light source
LED504070510114	114 LED 18 Watt
504070510114154	114 T5/ 54 Watt
LED504070510140	140 LED 18 Watt
504070510140154	140 T5/ 54 Watt

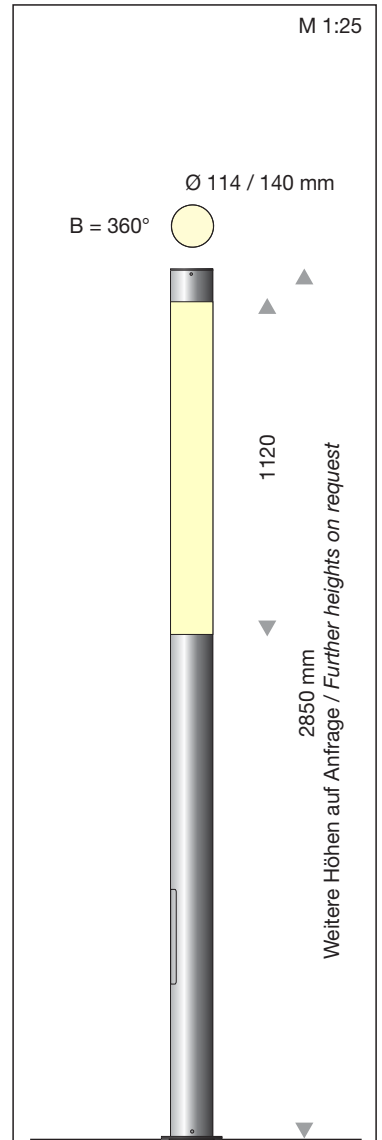
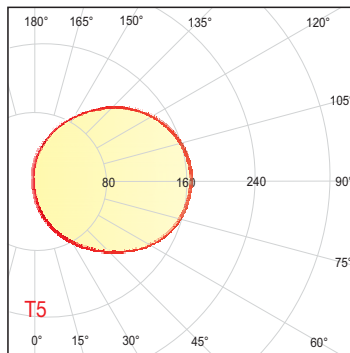
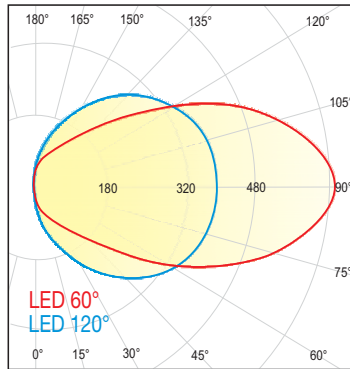

Bestell Nr. / item no.	für / for Ø
500101435	D114
500101569	D140

Bestell Nr. / item no.	Ø light source
LED504500510114	114 LED 54 Watt
504500510114154	114 T5/ 54 Watt
LED504500510140	140 LED 54 Watt
504500510140154	140 T5/ 54 Watt

